

Fix the timer to a wall in a covered location, sheltered from weather and splashing water; ambient temperature between 0 and 50 °C. Do not install the timer outdoors or in underground valve box.

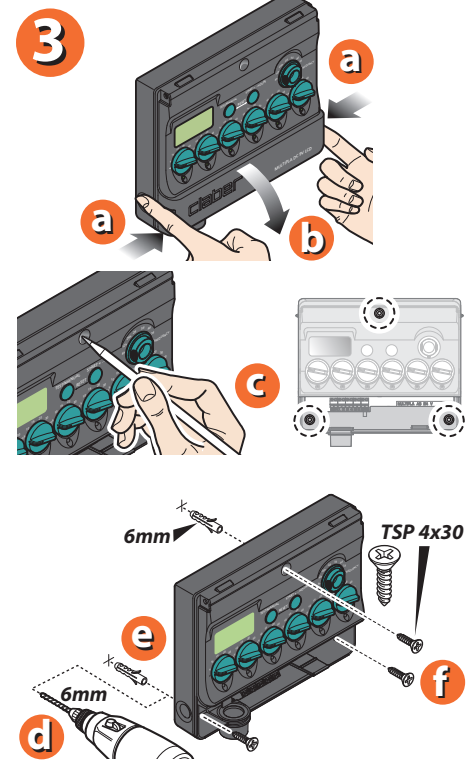

For Multipla 9V LCD (p/n): 8060

Electrical connections.

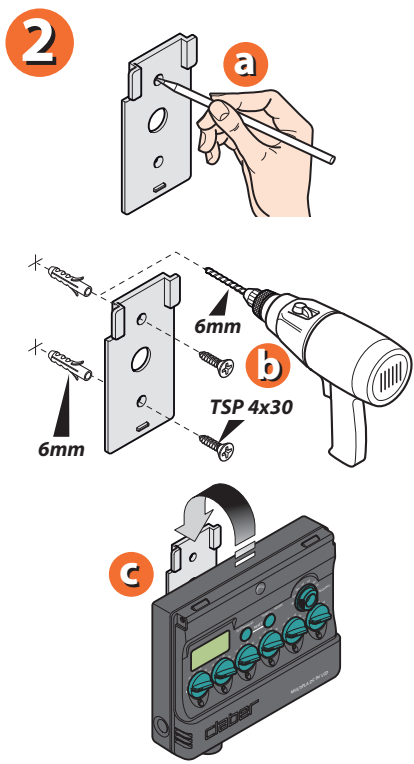
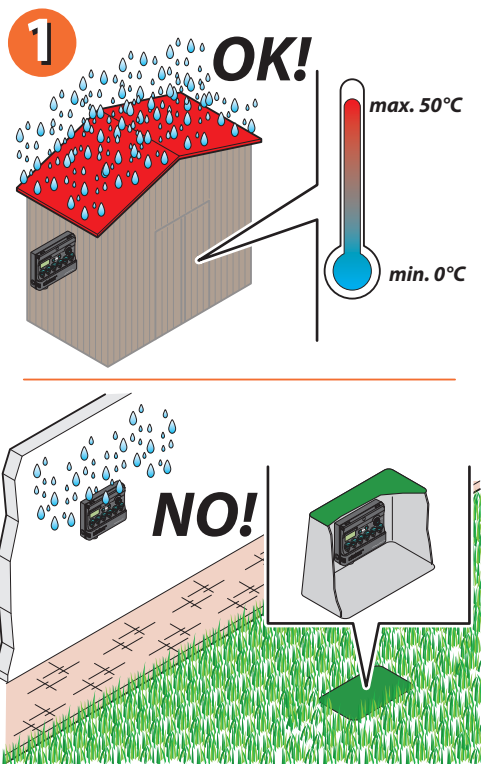
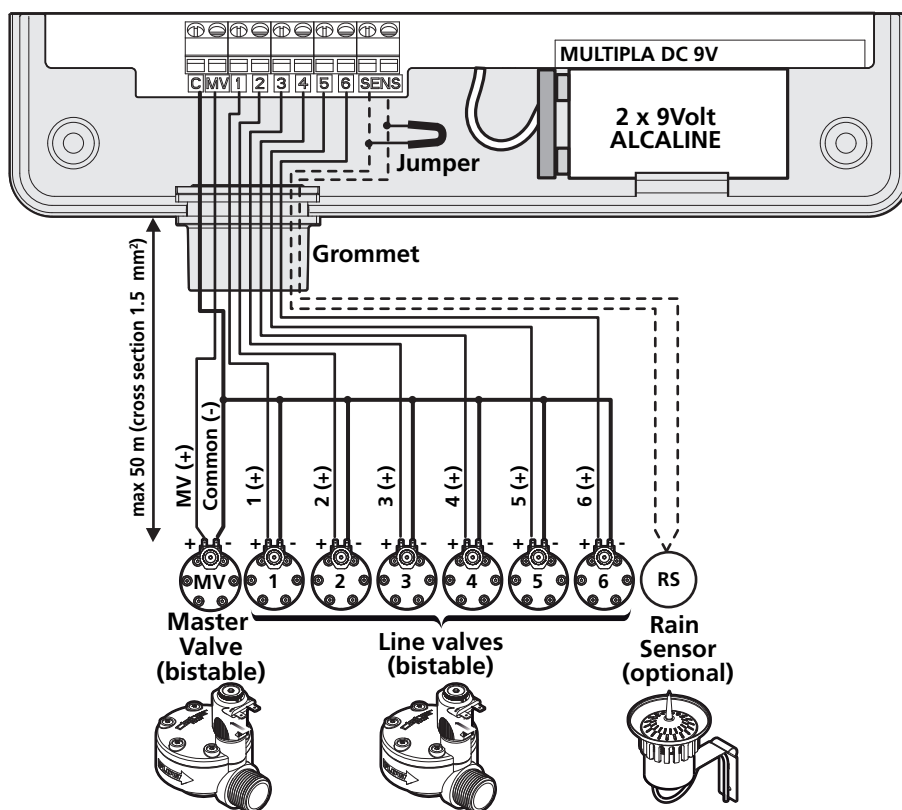

For Multipla 9V LCD (p/n): 8060

Remove the cover of the battery pocket from its seat, connect the batteries and position them in the pocket, applying light pressure. Use only new 9 volt alkaline batteries, type IEC 6LR61. Refit the battery cover. The appliance is able to operate with one battery only, although the life of the battery will be shorter (about 6 months with a daily watering program using four lines);

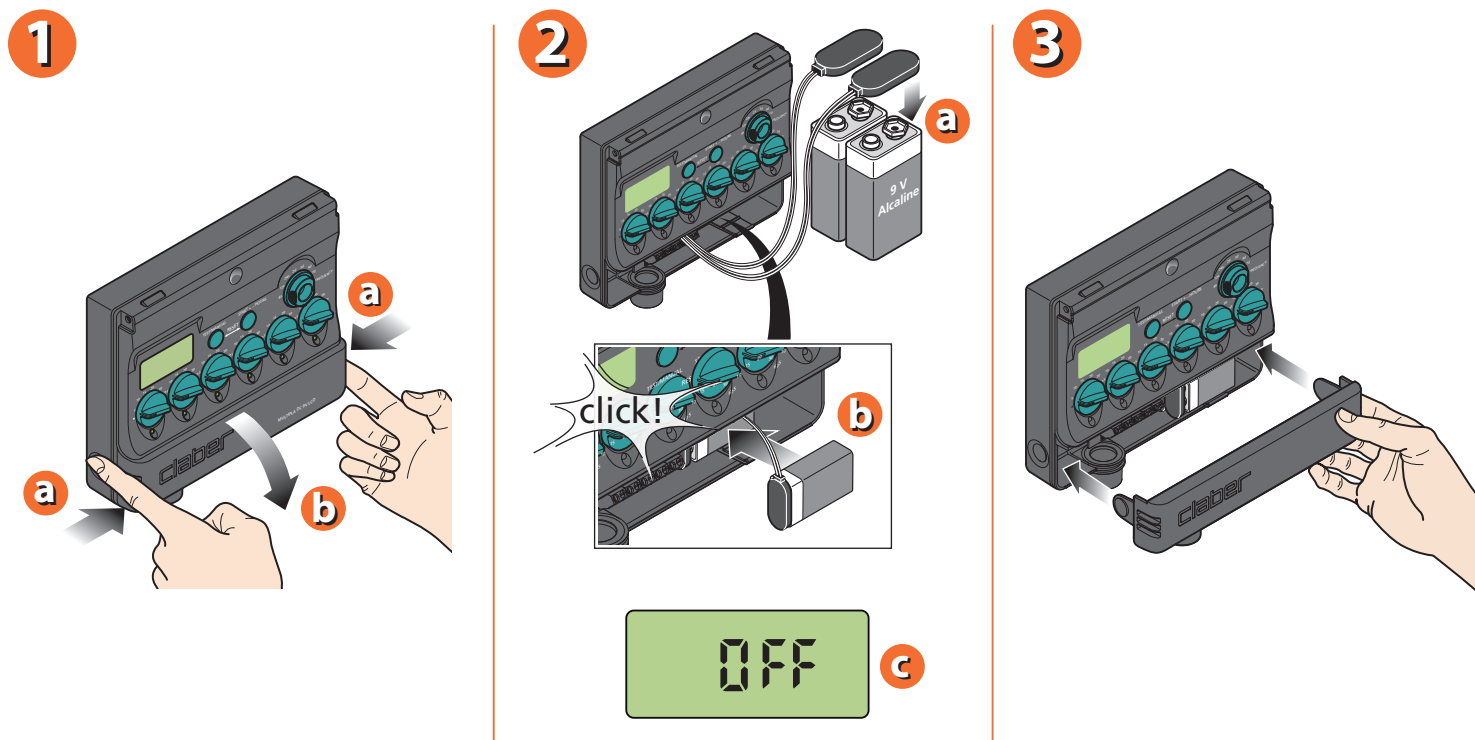

For Multipla 9V LCD (p/n): 8060

On fitting the batteries, the timer automatically runs a test cycle, closing all the valves, during which each of the Leds will blink once in turn.

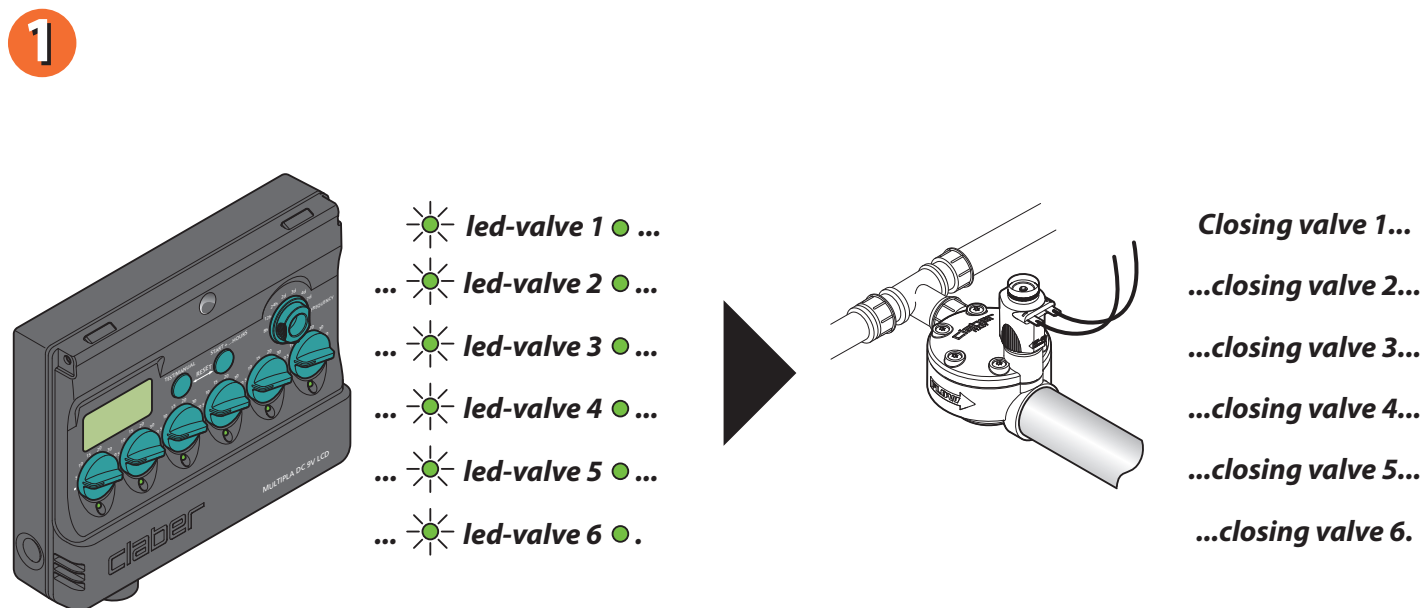

For Multipla 9V LCD (p/n): 8060

The TEST function can be used to perform a quick check on the system that will ensure its correct operation, by activating a given valve manually for a preset duration of 5 minutes. If there is a watering cycle in progress, it can be interrupted by pressing the TEST and START+... buttons. Press the TEST button repeatedly to select and activate one of the lines; after a few seconds, the relative valve will open for 5 minutes. To close the valve being tested before the end of the 5 minutes, press the TEST and START+... buttons simultaneously. The display indicates the operating mode — 'TEST' — the line selected, and the time remaining.

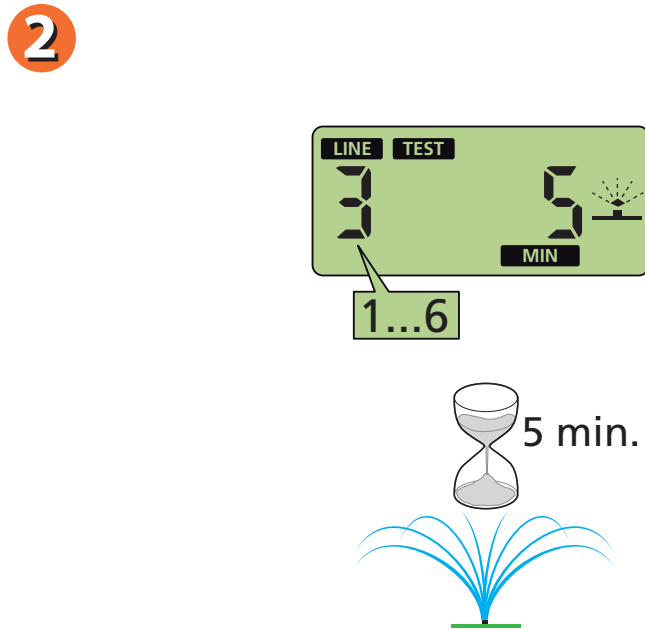
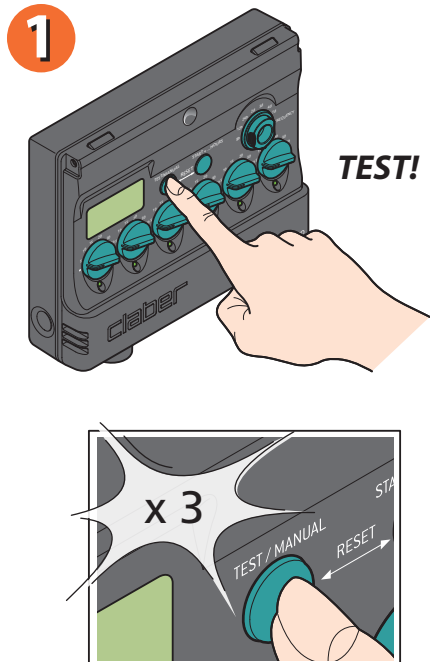

For Multipla 9V LCD (p/n): 8060

During a watering cycle, the Multipla activates all of the valves on lines 1 to 6 for which a watering time has been programmed using the LINE SELECTORS, opening them in succession and in ascending order. A watering program consists in the repetition of a watering cycle at intervals programmed with the FREQUENCY selector. Having decided which lines are to be activated, turn the LINE selector for each one until it is positioned on the required time. Watering can be programmed for a duration of between 5 and 60 minutes. To exclude watering on a given line, on the other hand, position the corresponding selector on • (zero).

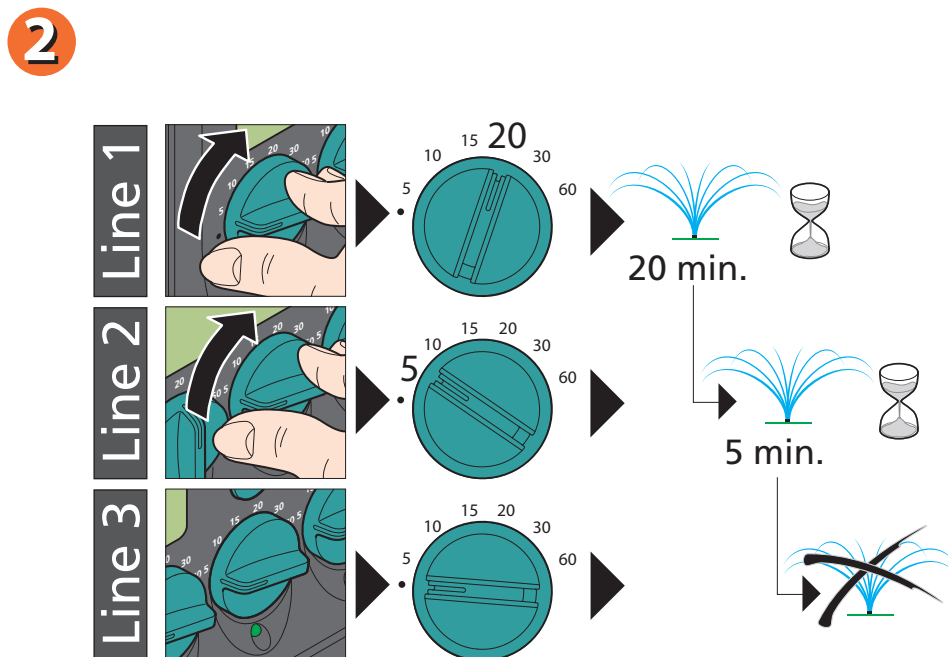
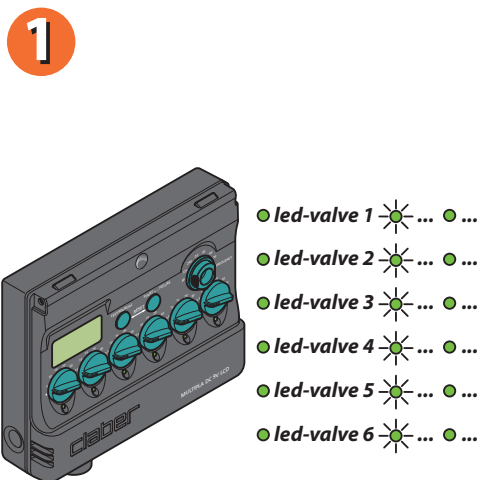

For Multipla 9V LCD (p/n): 8060

To set the watering frequency, turn the FREQUENCY selector to the required position (every 8, 12 or 24 hours, or 2, 3, 4 or 7 days)

1

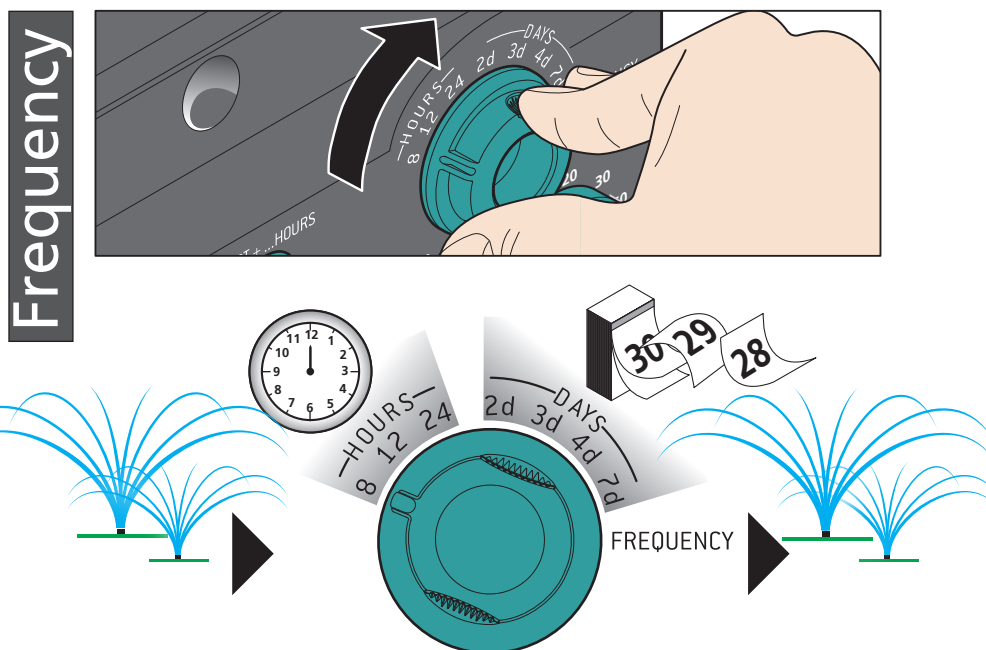

For Multipla 9V LCD (p/n): 8060

To start the program immediately, press the START+... button once. The next watering cycle will begin after the time period set with the FREQUENCY selector has elapsed (example: pressing the START+... button at 20:00 hours to activate the program, with the FREQUENCY set at 8 hours, the next watering cycle will commence at 04:00 hours).

1

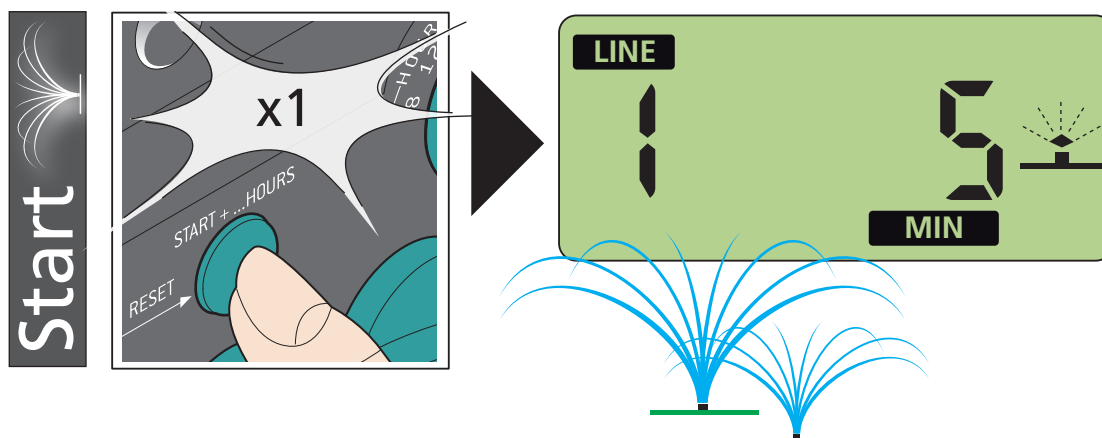

For Multipla 9V LCD (p/n): 8060

To delay the start of the program, press the START+... button a second time before 5 seconds have elapsed, to set a delay of one hour, a third time for two hours, and so on up to as many as 23 hours. The display momentarily indicates the number of hours delay selected, then the watering standby signal appears, together with the time remaining until the start of the first cycle.

1

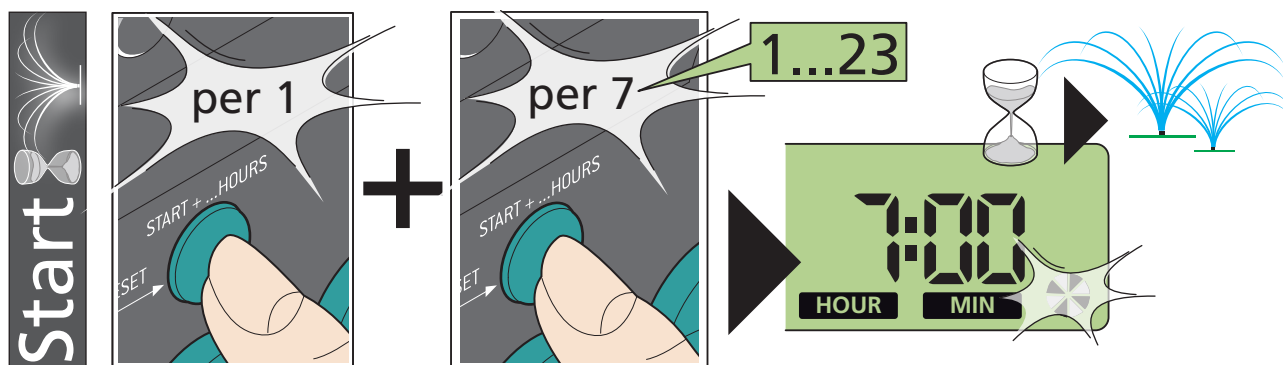

For Multipla 9V LCD (p/n): 8060

When a watering cycle is in progress, the display shows the in-progress symbol, the number of the line currently active, and the number of minutes remaining until watering is due to finish on that line. The valve currently open is also indicated by the relative Led, which blinks. On completion of the watering cycle, the standby signal reappears in the display, with the time remaining until the start of the next watering cycle. (example of watering cycle with FREQUENCY selector set to 8h).

1

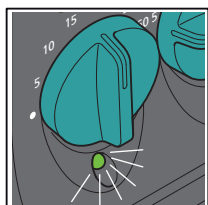

led-valve 1

2

Example of watering cycle with FREQUENCY selector set to 8h

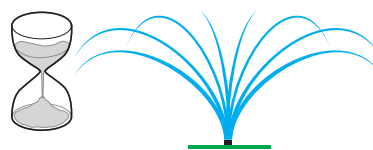

For Multipla 9V LCD (p/n): 8060

Example of programming: at 16:30, the duration is selected for all of the watering lines (LINE selectors) and the frequency is set at 8h (FREQUENCY selector). Suppose that watering is not to start immediately, but at 22:30 (i.e. after 6 hours): press the START+... button once, and then six times in succession, so that the display shows 6:00. The time indicated in the display begins counting down, ultimately reaching 0:00 at 22:30; the watering cycle starts, and will then be repeated every 8 hours as set with the FREQUENCY selector (i.e. at 22:30, at 06:30 and at 14:30).

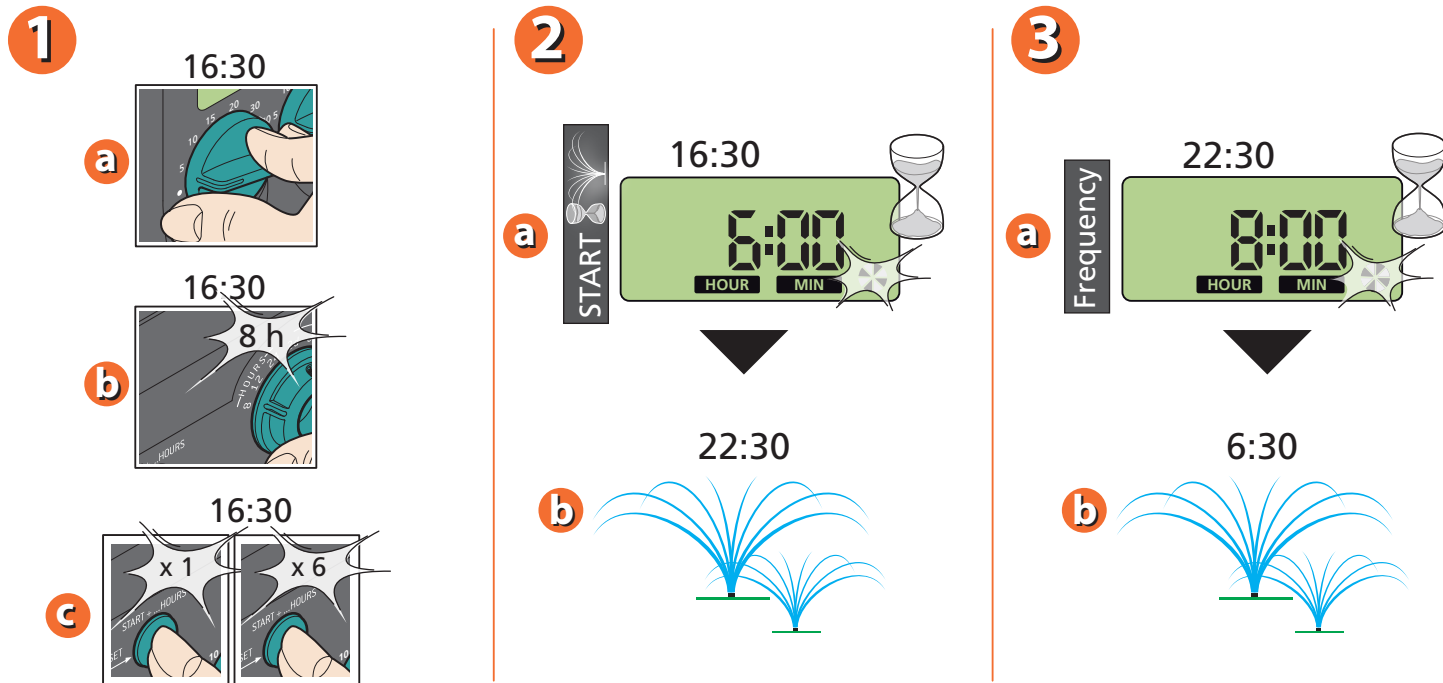

For Multipla 9V LCD (p/n): 8060

To change a watering program currently in use, enter the new LINE and FREQUENCY settings as desired.

The change will be rendered effective by the timer when appropriate.

Examples: - with watering in progress and line 2 active, the position of the LINE selectors is changed (say, from 10 min to 20 min): here will be no change to the duration of the watering step already in progress on line 2, whereas the new setting of 20 minutes will take effect with the activation of line 3.

- changing the position of the FREQUENCY selector (say, from 8 to 12 hours): the new setting will take effect within 24 hours subsequent to the change being made; thereafter, the watering cycles will be repeated at the new frequency selected, whilst the START time remains unchanged.

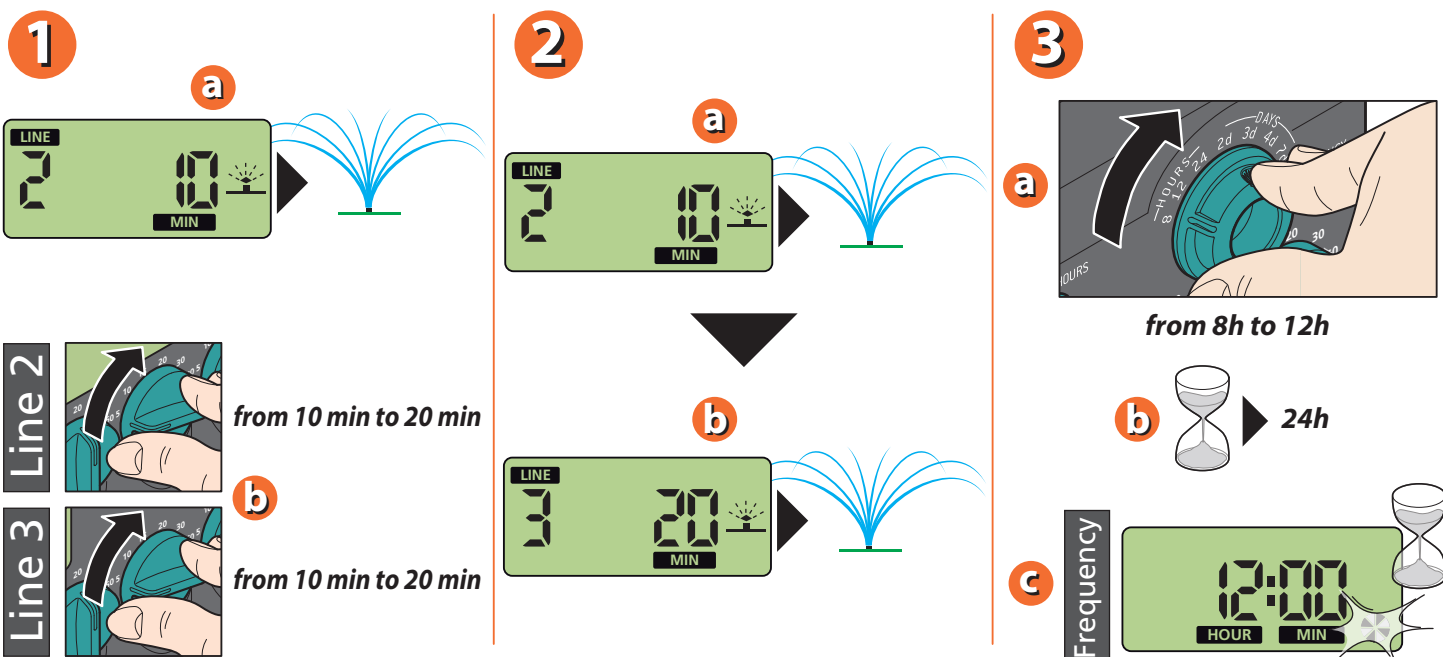

For Multipla 9V LCD (p/n): 8060

The STOP function interrupts the watering cycle currently in progress. Watering will restart as normal with effect from the cycle subsequent to the selected pause, as programmed by positioning the FREQUENCY selector. The STOP function can also be used to close a valve manually, when activated in TEST mode.

1

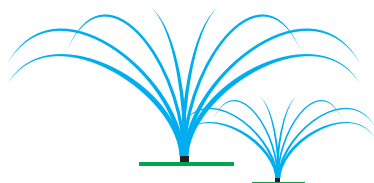

2

STOP

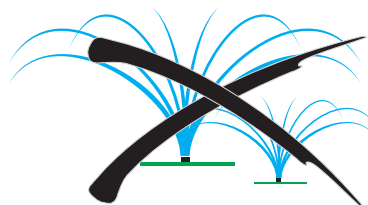
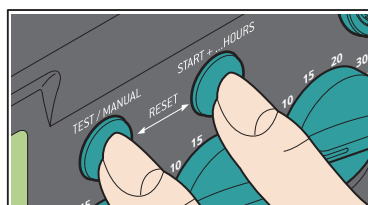

For Multipla 9V LCD (p/n): 8060

The RESET function closes the valve, if currently open, and switches the timer OFF. Watering will be suspended until the START+... button is pressed again, or until a TEST is run. To RESET the timer, press the START and START+... buttons simultaneously and hold for 5 seconds. The message OFF appears in the display.

1

RESET

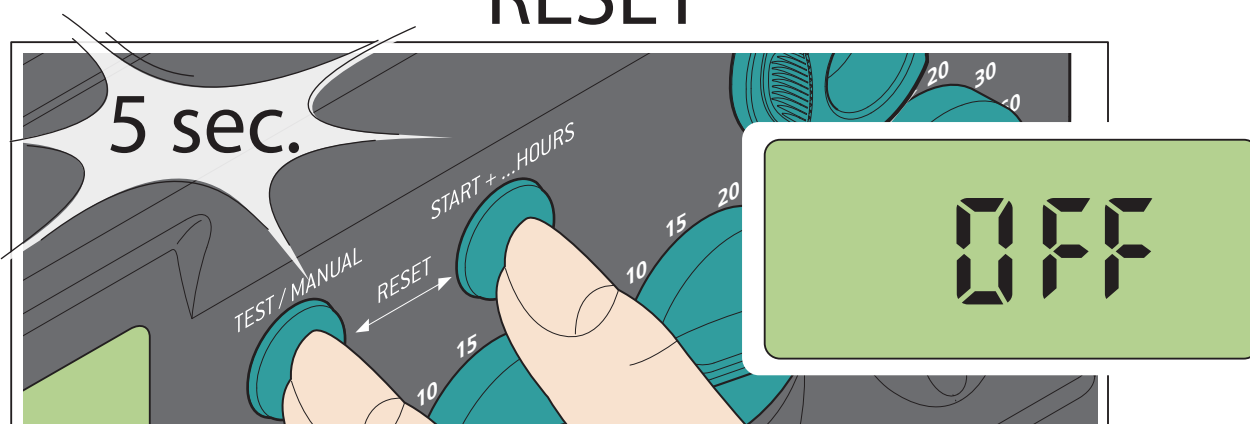

For Multipla 9V LCD (p/n): 8060

For more information and additional details, consult the instruction booklet accompanying the product.